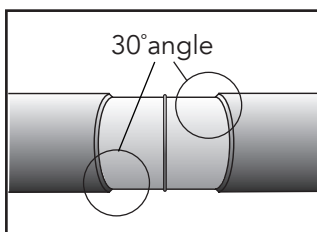

INSTRUCTIONS FOR USE**80EHSS™**

Premier Shrink Sleeve 80EHSS™ is a coating system designed for corrosion protection of field joints. Premier 80EHSS™ is suitable for use in conjunction with three layer polyethylene coated pipelines that operate at temperatures up to 80°C. The correct surface preparation and pre-heating is essential to achieving effective performance and full service life.

REQUIRED EQUIPMENT AND MATERIALS

- Propane Torch 100,000 to 150,000 BTU/hr
 - Propane Cylinders
 - Hose
 - Regulator
 - Rasp or coarse file
 - Hand held roller
 - Knife
 - Digital Thermometer with surface contact probe or Infra-red pyrometer
 - Cleaning solvent, clean rags
- Safety equipment typically includes:
- Safety Footwear
 - Overalls
 - Heat Resistant Gloves, Solvent Resistant Gloves
 - Eye Protection
 - Hard Hat

APPLICATION INSTRUCTIONS**1. BEVEL**

The edges of the adjacent coating shall be bevelled as shown.

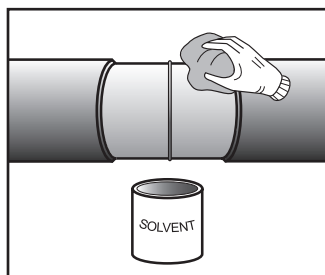
2. CLEAN

Thoroughly clean the area of the welded joint and the adjacent coating.
The area cleaned shall extend at least 100mm on to the adjacent coating.
The surface of the steel and adjacent coating shall be free from grease, oil, and dust. If solvent cleaning is required this shall be carried out according to Steel Structure Painting Council SSPC SP 1 using approved solvent, emulsion or cleaning compound.

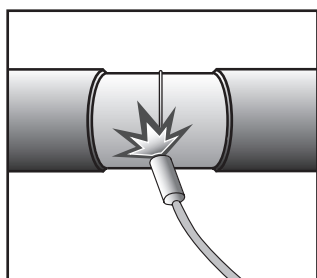
3. HEAT

Heat the steel surface to 50°C prior to blasting to avoid formation of condensation and prevent flash rusting.

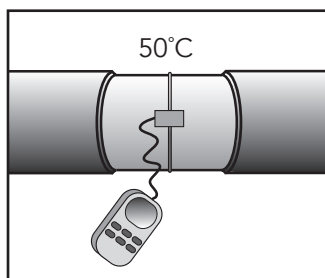
**4. SURFACE PREPARATION**

The preferred method of cleaning is Abrasive Blast Cleaning in accordance with one of the following standards: Steel Structure Painting Council SSPC SP 10, Swedish Standard Institution SIS 05 59 00 Sa 2½, International Standards Organization ISO 8501-1 Sa 2½.

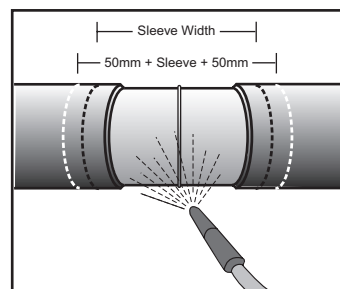

An abrasive blast profile of 50 microns minimum is required. Clean the area of the welded joint and the adjacent coating. The area cleaned shall extend at least 100mm on to the adjacent coating.

5. PRE-HEAT

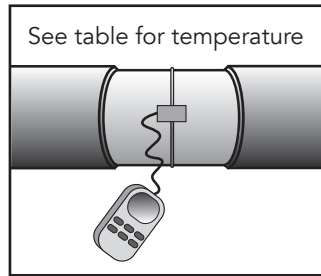
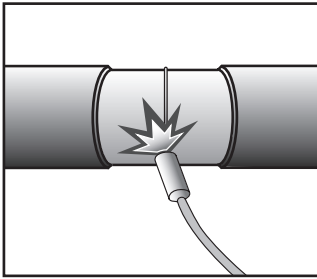

Measure the surface temperature to confirm that the correct value is achieved. An appropriate shelter may be used in wet or windy conditions.

Pre-heat the welded joint area and adjacent 50mm of main coating to the temperature shown in the table below. Optimal temperature will depend on site conditions and can be confirmed by ensuring that suitable adhesion pull-off values are obtained.

Ambient Temperature °C	Recommended Pre-heat °C
10	80
20	75
30	70
40	65
50	60

6. MIX EPOXY PRIMER

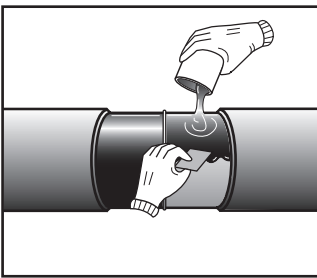

Mixing and application Instructions are provided with the Premier Epoxy pack.

Apply the mixed Premier Epoxy to the steel surface at a uniform thickness of 100 microns (minimum).

In a single operation, the primer is applied to the full width of the joint and at least 50mm onto the adjacent pipeline coating.

The remaining stages of application are carried out whilst the primer is still uncured or 'wet'.

7. PREPARE SLEEVE

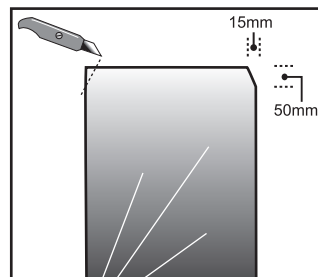

At the end of the sleeve that will form the underlap, use a knife to trim the corners (15mm x 50mm) as shown.

8. HEAT ADHESIVE

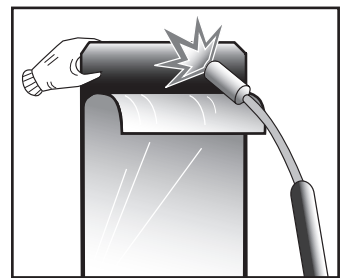

Peel back about 200mm of release liner from the trimmed end of the sleeve. Gently heat exposed adhesive.

9. POSITION SLEEVE

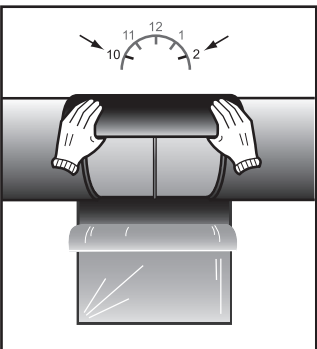

Position the heated adhesive on the pipe surface between the 10 and 2 o'clock position so that the sleeve overlaps onto the adjacent coating by 50mm minimum.

10. POSITION SEALING STRIP*

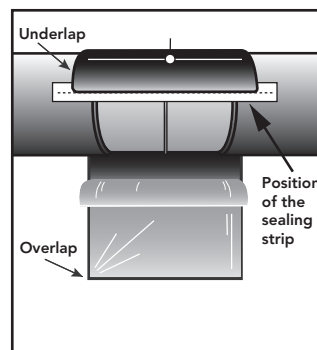

***This stage is dependant on sleeve thickness.**

Attach the sealing strip to the underside of the sleeve as shown and press down so that the sealing strip adheres.

11. JOIN SLEEVE TOGETHER OVER SEALING STRIP

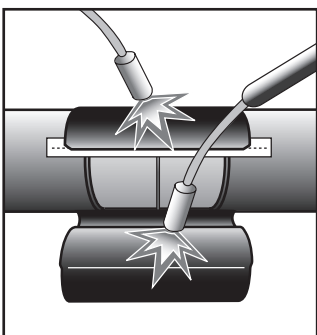

Completely remove the remaining release liner. Loosely wrap the sleeve around the pipe. Gently heat the sleeve at the underlap and the adhesive side of the overlap.

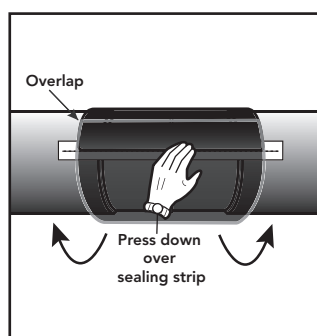

12. POSITION AND ATTACH CLOSURE PATCH

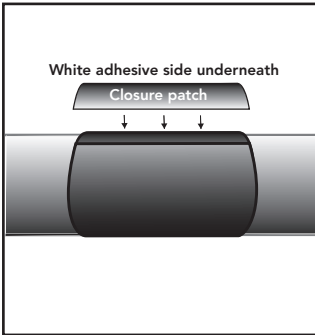

Heat the white side of the closure patch slightly so that the adhesive becomes tacky.

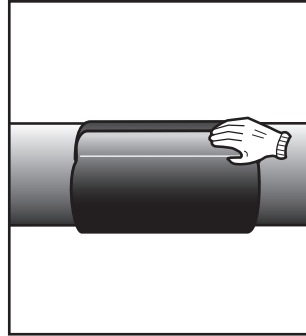

Heat the closure patch and attach it centrally to the overlapping end of the sleeve. With gloved hand press down firmly into place.

13. HEAT CLOSURE PATCH

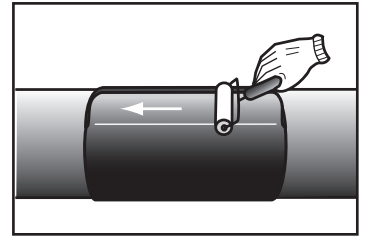
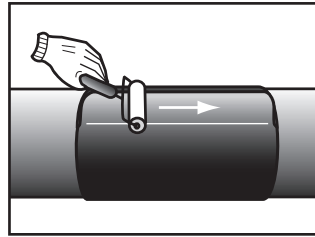
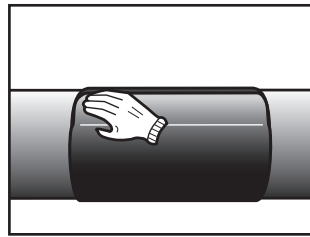
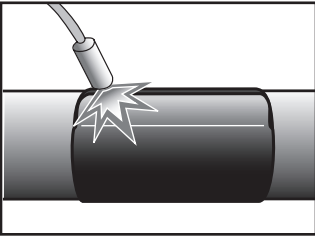

Gently heat the closure patch and smooth down firmly. Use a roller and a side-to-side motion to eliminate wrinkles and trapped air.

14. SHRINK SLEEVE

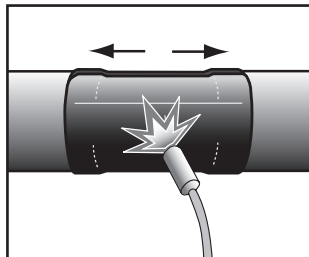
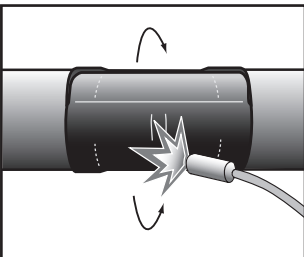

As the sleeve shrinks, continue heating along the sleeve from the centre to one end and then from the centre to the other end.

Use a blue flame and a continuous sweeping motion. Heat the sleeve starting from the centre and then heat around the pipe circumferentially.

15. POST HEAT

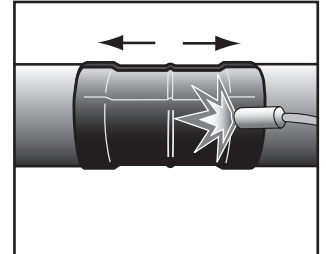

With a broad sweeping motion heat the entire surface of the sleeve until soft.

16. ROLL SLEEVE

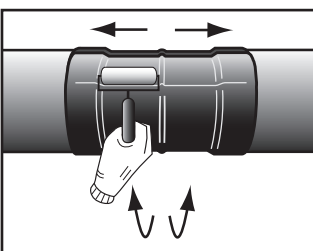

Whilst the sleeve remains soft, use a hand roller to remove any entrapped air. Start at the underside of pipe and work towards the crown.

Finally use the remaining Premier Epoxy primer to seal along the edges of the closure patch.

17. INSPECTION

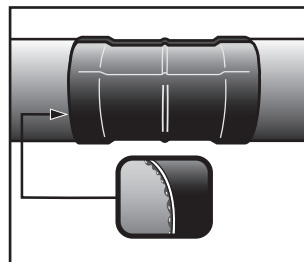

Visually inspect to ensure that:

The sleeve is in full contact with; the surface of the pipe, the weld bead and the adjacent coating.

The adhesive has flowed out at the edges of the sleeve around the whole circumference of the pipe.

No cracks or holes are present in the coating.

18. TESTING

The recommended Holiday detection voltage is 15 KV

19. REPAIRING DAMAGED SLEEVES (A) surface defects smaller than 1cm²

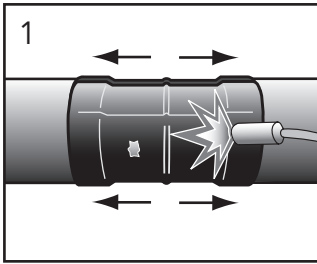

1. Use a low yellow flame to pre-heat the coating. With quick back and forth strokes, pre-heat the repair zone to remove any moisture.

2. Heat the melt stick up until it becomes fluid, spreading it over the damaged area simultaneously.

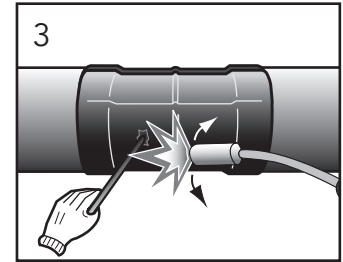
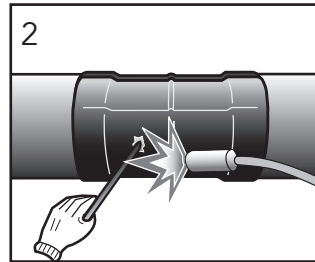

3. Keep the flame moving to prevent damage to the coating.

19. (B) surface defects larger than 1cm²

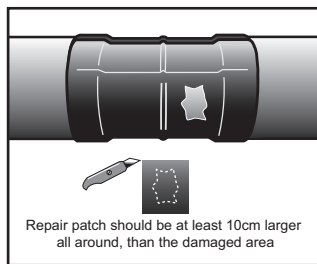

1. Prepare the damaged area by cutting back any protruberances and smoothing uneven surfaces etc. Cut a repair patch large at least 10cm bigger all around than the damaged area.

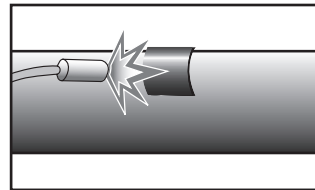

2. Fill the main recessed damaged area with the heated melt stick and use a trowel to smooth the melted compound while still hot. Before applying the repair patch, warm the damaged area to remove any existing moisture

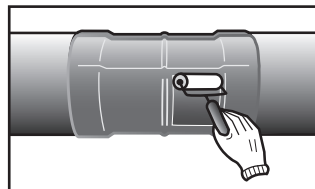

3. Place the patch with the adhesive side up on a gloved hand or on the top of the pipe, and heat gently until the adhesive softens and surface becomes glossy.

4. Put the softened adhesive side of the patch to the damaged area and press down firmly. Use a roller to ensure a good bond.

19. (C) surface defects that can't be repaired

Removal and recoating must be used. Please refer to the INSTALLATION PROCEDURE.

HEALTH & SAFETY

These application instructions do not constitute a risk assessment. We recommend that installation is carried out with due regard to Health and Safety and in accordance with relevant local statutes and regulations. Safety Data Sheets are available on request.

STORAGE

- Store correct way up in original packaging.
- Store away from heat and open flames.
- Do not store in direct sunlight.
- Store in a ventilated area.
- Temperatures should be 5°C and 35°C.
- Do not stack pallets.

IMPORTANT: Winn & Coales (Denso) Ltd pursue a policy to develop and continually improve all of our products and therefore information given in these instructions for use is intended as a general guide and does not constitute a warranty, specification or risk assessment. Instructions for use are intended to provide sufficiently detailed information to achieve successful installation in normal circumstances. These guidelines may not cover all circumstances; however, our sales personnel are committed to assisting the user in establishing the suitability of the product for its intended purpose and additional specific information, advice and training (including Safety Data Sheets) is available. It is strongly recommended that installation is conducted with due regard to Health and Safety using a safe system of work, including risk assessments and method statements, in accordance with relevant local statutes and regulations. Equipment used for installation must be suitable for the intended use, maintained in a safe condition, inspected for signs of deterioration, and used by competent personnel. Any conflict between these guidelines and the specific project specifications must be resolved by the user before work commences. All rights reserved.

DISPOSAL

Please minimise or avoid waste wherever possible. Please do not discard waste material, including packaging, in the surrounding environment. Follow all relevant legislation for disposal.



WINN & COALES (DENSO) LTD

Denso House, Chapel Road, London, United Kingdom

TEL: +44 (0) 208 670 7511 • EMAIL: mail@denso.net

WEB: www.denso.net

A MEMBER OF WINN & COALES INTERNATIONAL

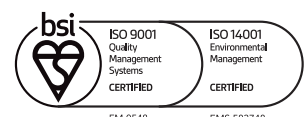

FM 0548

EMS 583748

PUB No. 404.11.2022